

Plastic tube flowmeters Series PT/PS



Variable area flowmeter for liquids and gases

- Low cost, excellent readability and light weight
- Simple installation (flanged, threaded or socket ends for solvent or fusion welding connections)
- Wide range of operating temperatures with several combinations of tube and fittings materials
- Scaled directly in l/h, m³/h, %, ... Special scales for liquids and gases on request
- Flow rate:
 - Water: 4 l/h ... 50 m³/h
 - Air: 200 Nm³/h ... 1500 Nm³/h
- Accuracy:
 - Models PT/PS: 4% (q_G=50%)
 - Models PTM/PSM: 6% (q_G=50%)
- Connections:
 - DIN flanges DN15 ... DN80
 - BSP or NPT threaded connections ½" ... 3"
 - Solvent weld socket PVC connections
 - Stainless steel & PP connections for welding
- Materials:
 - Measuring tube: Polysulfone and NAS®. Trogamid® T available on request
 - Fittings: PVC, steel, EN 1.4404 (AISI 316L), PP
 - Float: EN 1.4404 (AISI 316L), aluminium, PVC, PVDF, PTFE, ...
 - Gaskets: NBR, VITON®, EPDM
- Local indication
- Options:
 - 1 or 2 limit switches
 - Electronic transmitter with 4-20 mA analog output (18 points max.). Ex version and HART, PROFIBUS or FIELDBUS protocols available on request



Working principle

Variable area flowmeter using a float in a tapered tube made of special plastic materials.

The fluid flows up through the tapered tube forcing the float to a position with sufficient free area to enable the flow to pass. This free area is related to the flow rate, the weight of the float and the density and viscosity of the fluid.

The pressure drop across the flowmeter remains constant over the entire flow range, since it is related to the fluid density and the float weight and dimensions. Flow indication is achieved since the area of flow increases as the flow rate increases.

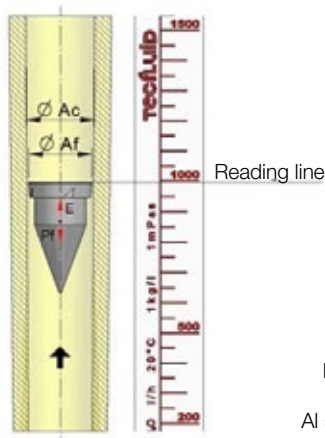

A_c = Tube area
 A_f = Float area
 P_f = Float weight
 E = Fluid force
 $A_l = A_c - A_f$ = Free area

Applications

- Water & waste water treatment
- Chemical & petrochemical industry
- Paper industry
- Pharmaceutical, cosmetics & synthesis
- Refrigeration & air conditioning
- Refining
- Osmosis
- Gas processes

Models

- PS/PSM Polysulfone tube: PSU (polysulfone)
- PT/PTM Trogamid® T tube: PA (polyamide)
- PTM03 NAS® tube: PS (polystyrene)

Technical data

- **Accuracy**, acc. to VDI/VDE 3513 sheet 2 ($q_G=50\%$):
 - PT / PS: 4%
 - PTM / PSM: 6%
- **Scales calibrated in l/h, m³/h, %**
Special scales for liquids and gases on request
- **Scale range:** 10:1

• Scale length:

- PT / PS: 160 ± 5 mm
- PTM / PSM: 100 ± 5 mm

• Fluid temperature:

- Models PT/PTM: max. 60°C
- Models PS/PSM, with connections in:
 - PVC: max. 60°C
 - PP: max. 90°C
 - EN 1.4404 / Steel:
 - NBR gaskets: max. 100°C
 - VITON® gaskets: max. 110°C
- Model PTM03: max. 40°C

• Working pressure: depending on size, up to 15 bar

• Connections:

- PT11 / PS31: BSP thread or socket ends for solvent welding 1/2" ... 3"
- PT12 / PS32: DIN flange DN15 ... DN80
- PTM01 / PSM21: BSP thread or socket ends for solvent welding 1/2" ... 3/4"
- PTM02 / PSM22: DIN flange DN15 ... DN20
- PTM03: BSP thread or socket ends for solvent welding 1/2" ... 3/4"

Other connections available on request

• Trogamid® T tubes only available on request

Operation

- Vertical with upwards flow

Limit switches and transmitters

- **PT-AMR1 ... 2:** 1 ... 2 magnetic actuated reed switches
- **PT-TMUR:** 0 ... 4-20 mA, 4-wire system (16...18 points resolution for models PT/PS)
- **PTM-TMUR:** 0 ... 4-20 mA, 4-wire system (11 points resolution for models PTM/PSM)

Other transmitters on request:

- 2-wire system
- Ex protection
- HART, Profibus or Fieldbus protocols

Float types

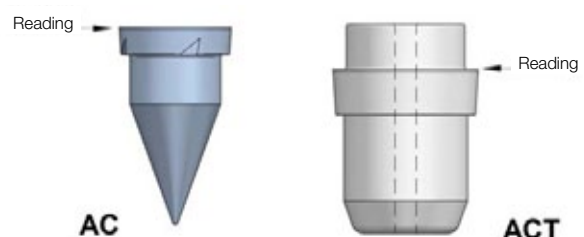

Models

PT ... PS ... PTM ... PSM / PVC ... PP

BSP thread 1/2" ... 3"

Socket ends for welding DN15 ... DN80



PT ... PS ... PTM ... PSM / Fully SS
EN 1.4404 (AISI 316L)

Socket ends for welding DN15 ... DN80



PT ... PS ... PTM ... PSM / Fully Steel ...
Fully SS EN 1.4404 (AISI 316L)

BSP/NPT thread 1/2" ... 3"



PT ... PS ... PTM ... PSM / Steel ... SS, with
PVC nuts and Steel / EN 1.4404 (AISI 316L)
end connector:

BSP/NPT thread 1/2" ... 3"



PT ... PS ... PTM ... PSM / PVC ... PP

DIN flange DN15 ... DN80

Other flange standards available on
request with BR flanged models



Materials

PT11, PS31 / PTM01, PSM21, PTM03

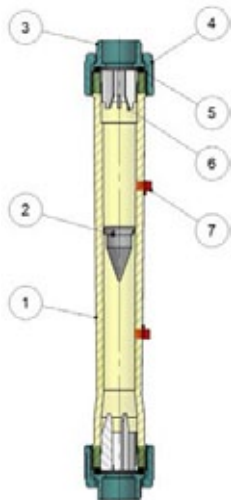

PT12, PS32 / PTM02, PSM22

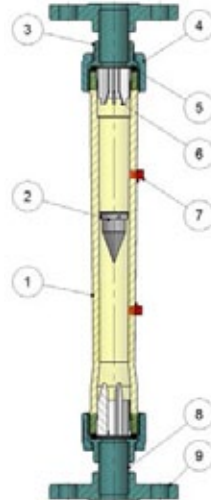

PT12-BR, PS32-BR

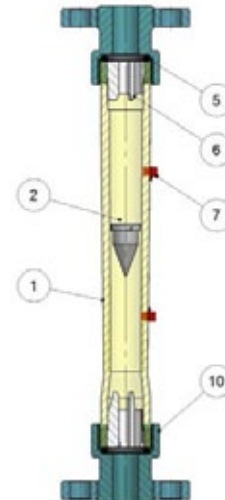

N°	Description	Materials		
		PS31/32, PSM21/22, PS32-BR	PTM03	On request PT11/12, PTM01/02, PT12-BR
1	Flow tube	POLYSULFONE	NAS®	TROGAMID®
2	Float	EN 1.4404 (AISI 316L), PTFE, PTFE+Pb, PVDF, PVDF+Pb, Aluminium, PVC, PVC+Pb	EN 1.4404 (AISI 316L), PTFE, PTFE+Pb, PVDF, PVDF+Pb, Aluminium, PVC, PVC+Pb	Hastelloy, Titanium
3	Fitting	PVC	PVC	PP, Steel, AISI 316L
4	Nut	PVC	PVC	PP, Steel, AISI 316L
5	Gasket	NBR	NBR	VITON®, EPDM
6	Float stop	PVDF	PVDF	-
7	Flow indicator	PVC	PVC	-
8	Tube union	PVC	PVC	PP
9	Flange	PVC	PVC	PP
10	Flange group	PVC	PVC	PP

Dimensions

PT11 / PS31

R"	DN	E	RE	A	L	L1	L2	H
1/2"	15	20	1 1/4"	52	346	300	326	16
3/4"	20	25	1 1/4"	52	346	300	326	16
1"	25	32	2"	74	366	300	328	20
1 1/2"	40	50	2 1/4"	80	374	300	334	24
2"	50	63	2 3/4"	100	390	300	340	30
2 1/2"	65	75	4"	138	420	300	344	34
3"	80	90	4"	138	420	300	344	34

PT12 / PS32 ... PT12-BR / PS32-BR

DN	E	D	k	g	lxn°	B	L	L (BR)
15	20	95	65	45	14x4	12	408	378
20	25	105	75	58	14x4	13	408	378
25	32	115	85	68	14x4	15	424	398
40	50	150	110	88	18x4	17	456	400
50	63	165	125	102	18x4	19	476	412
65	75	185	145	122	18x4	21	522	420
80	90	200	160	138	18x8	22	548	420

PTM01 / PSM21 / PTM03

R"	DN	E	RE	A	L	L1	L2	H
1/2"	15	20	1"	43	232	192	212	12
1/2"	15	20	1 1/4"	53	232	192	212	15
3/4"	20	25	1 1/4"	53	232	192	212	14

PTM02 / PSM22

DN	E	D	k	g	lxn°	B	L
15	20	95	65	45	14x4	12	294
15	20	95	65	45	14x4	12	294
20	25	105	75	58	14x4	13	294

All dimensions in mm

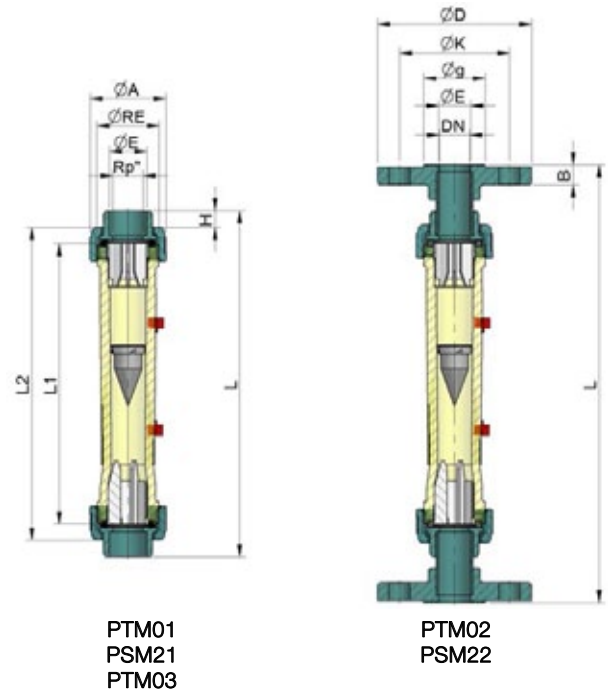
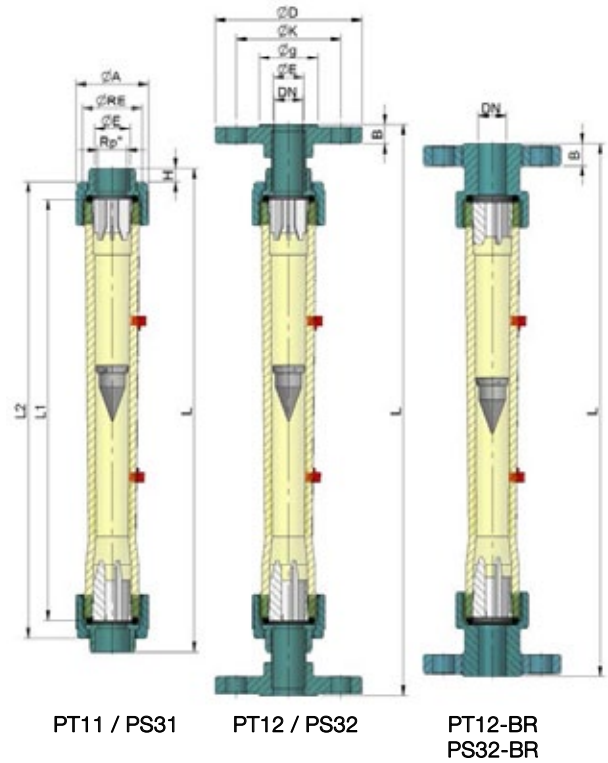

Flow ranges

Model N°	Flow scales EN 1.4404 float 7.95 g/cm ³			Flow scales Aluminium float 2.85 g/cm ³		Max. operating pressure bar	R" (DN)	D _{ext}
	l/h water	Nm ³ /h air	ΔP	Nm ³ /h air	ΔP			
		1.013 bar abs 20°C	mbar	1.013 bar abs 20°C	mbar			
PS-312-0160 ⁽¹⁾	16-160 ⁽¹⁾	-	10 ⁽¹⁾	0.6-6 ⁽¹⁾	-	15	½" (DN15)	20
PS-312-0250 ⁽¹⁾	25-250 ⁽¹⁾	-		1-10 ⁽¹⁾				
PS-313-0400	40-400	1.2-12	12	0.7-7	5	10	¾" (DN20)	25
PS-313-0630	60-630	1.9-19		1.1-11				
PS-313-1000	100-1000	3-30		1.8-18				
PS-314-1600	160-1600	4.5-45	18	2.5-25	8	10	1" (DN25)	32
PS-314-2500	250-2500	8-75		5-45				
PS-315-4000	400-4000	12-120	23	7-70	10	8	1 ½" (DN40)	50
PS-315-6300	500-6300	15-190		10-110				
PT-316-6300	500-6300	15-190		10-110		8	2" (DN50)	63
PS-316-M010	1000-10000	30-300	30	20-180	12			
PS-316-M014	2000-14000	60-430		40-250		8	2 ½" (DN65)	75
PS-317-M016	1600-16000	50-490		30-290				
PS-317-M020	2000-20000	60-600		40-360		17	3" (DN80)	90
PS-317-M025	2500-25000	80-770	40	50-460				
PS-317-M030	3000-30000	90-920		60-550		17	3" (DN80)	90
PS-317-M040	6000-40000	190-1200		110-730				
PS-317-M050 ⁽²⁾	9000-50000	280-1500		170-920				

⁽¹⁾ with PTFE float

⁽²⁾ fits special float to reach higher flow rate

For PT / PS series, all plastic loaded floats are in PVDF+Pb, except for tube models PS-316-M014 ... M050, in PVC+Pb

Model N°	Flow scales EN 1.4404 float 7.95 g/cm ³			Flow scales Aluminium float 2.85 g/cm ³		Max. operating pressure bar	R" (DN)	D _{ext}
	l/h water	Nm ³ /h air	ΔP	Nm ³ /h air	ΔP			
		1.013 bar abs 20°C	mbar	1.013 bar abs 20°C	mbar			
PSM-312-0040 ⁽¹⁾	4-40 ⁽¹⁾	-	3 ⁽¹⁾	0.2-1.6 ⁽¹⁾	-	15	½" (DN15)	20
PSM-312-0060 ⁽¹⁾	6-60 ⁽¹⁾	-		0.3-2.5 ⁽¹⁾				
PSM-312-0100	10-100	0.3-3	10	0.2-1.8	4	15	¾" (DN20)	25
PSM-312-0160	16-160	0.5-5		0.3-3				
PSM-312-0250	25-250	0.8-7.7		0.5-4.5				
PSM-313-0400	40-400	1.2-12	12	0.7-7	5	15	½" (DN15)	20
PSM-313-0630	60-630	1.9-19		1.1-11				
PSM-313-1000	100-1000	3-30		1.8-18				

⁽¹⁾ with PTFE float

Limit switches

Adjustable limit switch PT-AMR

Bi-stable SPST reed switch, actuated by a magnet inside the float and mounted in a PVC enclosure:

- PT-AMR1 ... 2: 1 ... 2 adjustable reed switches
- Standard: normally opened (NO) switches. Normally closed (NC) reed switches are available on request.
- Operation: the standard contact is normally opened. That means:
 - Maximum flow: on increasing flow, the contact closes when the float reaches the height of the alarm sensor. It remains closed while the float is above the sensor. It opens again when the flow rate decreases and the float returns to a position below the sensor.
 - Minimum flow: on decreasing flow, the contact closes when the float reaches the height of the alarm sensor. It remains closed while the float is below the sensor. It opens again when the flow increases and the float rises to a position above the sensor.
- Enclosure: PVC
- Ambient temperature: -15°C ... +60°C
- Contact rating: 0,5 A / 250 VAC / 12 VA
- Hysteresis: ±5% of full scale value
- Ingress protection degree: IP65
- DIN 43650-A connector, PG9 cable gland
- Conforms to 2006-95-EC Directive
- Suitable for hazardous area, considered as "Simple apparatus"

Mounting

Once the electrical connection has been made and the cable gland has been tightened, mount the female connector (A) on the male base (C), placing the seal (B) between the two pieces.

To fix the limit switch in its position on the flowmeter, unscrew the screw (E) to release the bracket (D), place the limit switch on the desired point at the tube and reassemble the bracket by tightening the screw (E).

Electrical connection

In the female connector (A):

- Term. 1: Reed switch contact
- Term. 2: Reed switch contact
- Term. 3: No connection
- Earth terminal: No connection

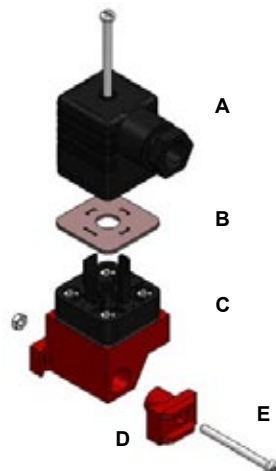
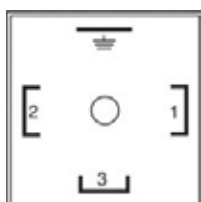

PTM/PSM
with 1 reed switch

PT/PS
with 2 reed switches



Dimensions series PT + limit switch (in mm)

DN	15	20	25	40	50	65	80
R	1/2"	3/4"	1"	1 1/2"	2"	2 1/2"	3"
A	47	52	62	70	70	90	90

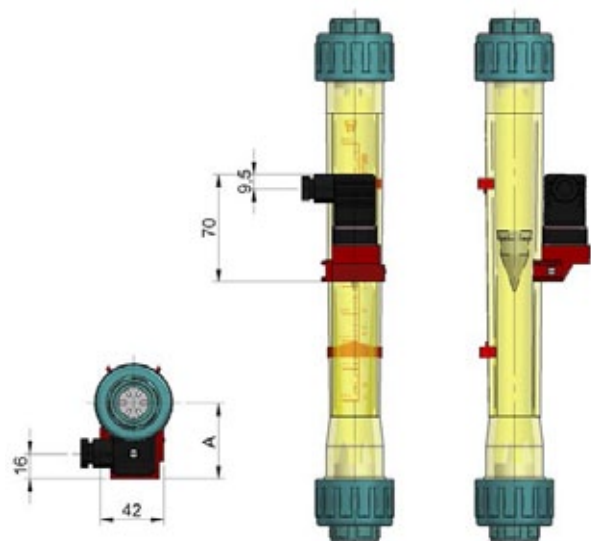

Transmitters

Transmitter PT-TMUR 0 ... 4-20 mA
(18 points, for ½" ... 2")
(16 points, for 2½" ... 3")

Transmitter PTM-TMUR 0 ... 4-20 mA (11 points)

The TMUR electronic transmitter consists of a reed chain which is mounted inside a plastic enclosure IP65 rated. This device is attached to the side of the flow tube. By means of a converter, the resistance signal is converted in to current (0 ... 4-20 mA).



PT/PS + PT-TMUR



PTM/PSM + PTM-TMUR



TR420
(remote converter
Ω/mA)

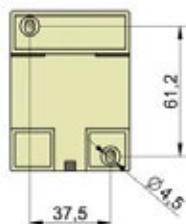
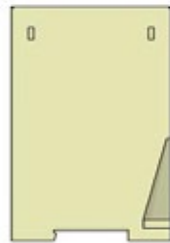
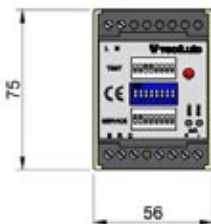
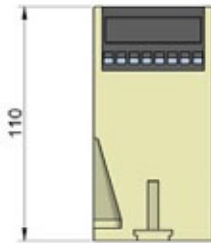

TMUR technical data

- Working temperature: +5°C ... +60°C
- Resolution: 10 mm

4-wire system

TR420 converter technical data

- DIN 46277 rail mounted
- Power supply: 24, 110, 230, 240 VAC 50/60 Hz / 24 VDC
- Consumption: <1 VA
- Outputs: 0-20 mA, 4-20 mA, 0-5 V, 0-10 V, 1-5 V, 2-10 V



**2-wire system
(on request)**

- 24VDC power supply
- Suitable for hazardous area with ATEX certification
- HART, Profibus or Fieldbus protocols
- Power supply:
 - 8 ... 35 VDC, safe area version
 - 8 ... 30 VDC, hazardous area version
- Consumption: 0,8 W
- Output: 4-20 mA
- Hazardous area version ATEX certified Ex ia IIC T6

For 2-wire system, the electrical connection is made directly on terminals mounted in an IP67 housing, compact mounted on the reed chain.

Dimensions series PT + transmitter TMUR (in mm)

DN	15	20	25	40	50	65	80
A	95	105	110	120	130	145	145

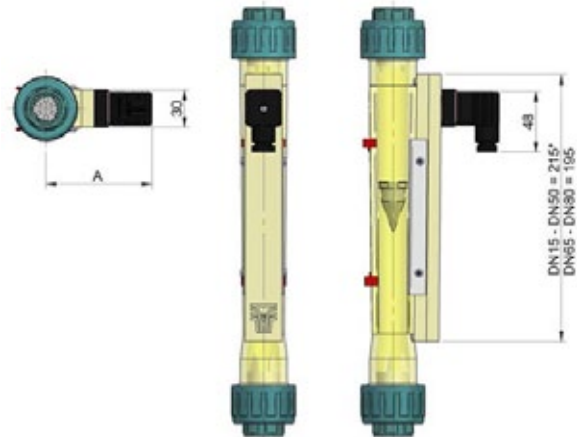

*PTM ... PSM 139 mm